INSTRUCTION MANUAL
ATLAS



ATLAS

POLED CANVAS SERIES



KEY TIPS

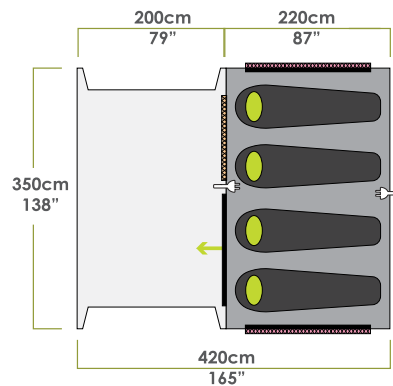

Make sure all frame parts are clean and dry before packing away. Never store parts inside each other, if wet they will oxidise and rust.



Clean any bird droppings from your tent but never use harsh detergents. Use warm water with a soft bristled brush to clean and allow to dry completely.



Always dry your tent before storing away. Mould can start to form within days if left wet in the bag.



If you experience heavy rain or morning dew, flick the inside of the cover a few times to remove water from the mesh panel before opening the cover.



Look after the zips by cleaning them regularly. Use an old toothbrush to clean any build up from the teeth. If camping by the sea, clean and then treating with a silicone spray will increase the lifespan of the zip.



Before lifting the side eve poles into position open the front door partially and side windows to allow air to enter the tent.



CANVASLITE SUNROOM

Encloses all 3 sides of the front awning, creating a protected living or kitchen area. The perfect addition to your ZEMPIRE® canvas tent.

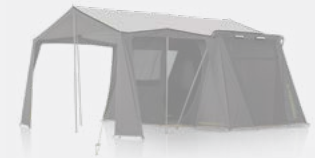

ATLAS ROOF COVER

Helps reduce internal temperature and keeps the inside of your tent darker. This cover also protects your tent roof from pollen, tree sap and other debris.



MONSTAMAT TWIN

Our most comfortable sleeping mat to date! The Monstamat Twin is a double-width camping mattress with a luxurious stretch fabric, durable base and 360° two-way valve.



ATLAS SOLID GROUND SHEET

Designed to protect the tent floor & simplify clean-up. Made from PE, it fits perfectly under your tent with corner peg points.



OPTIONAL ADDONS

POLE DIAGRAM - ATLAS

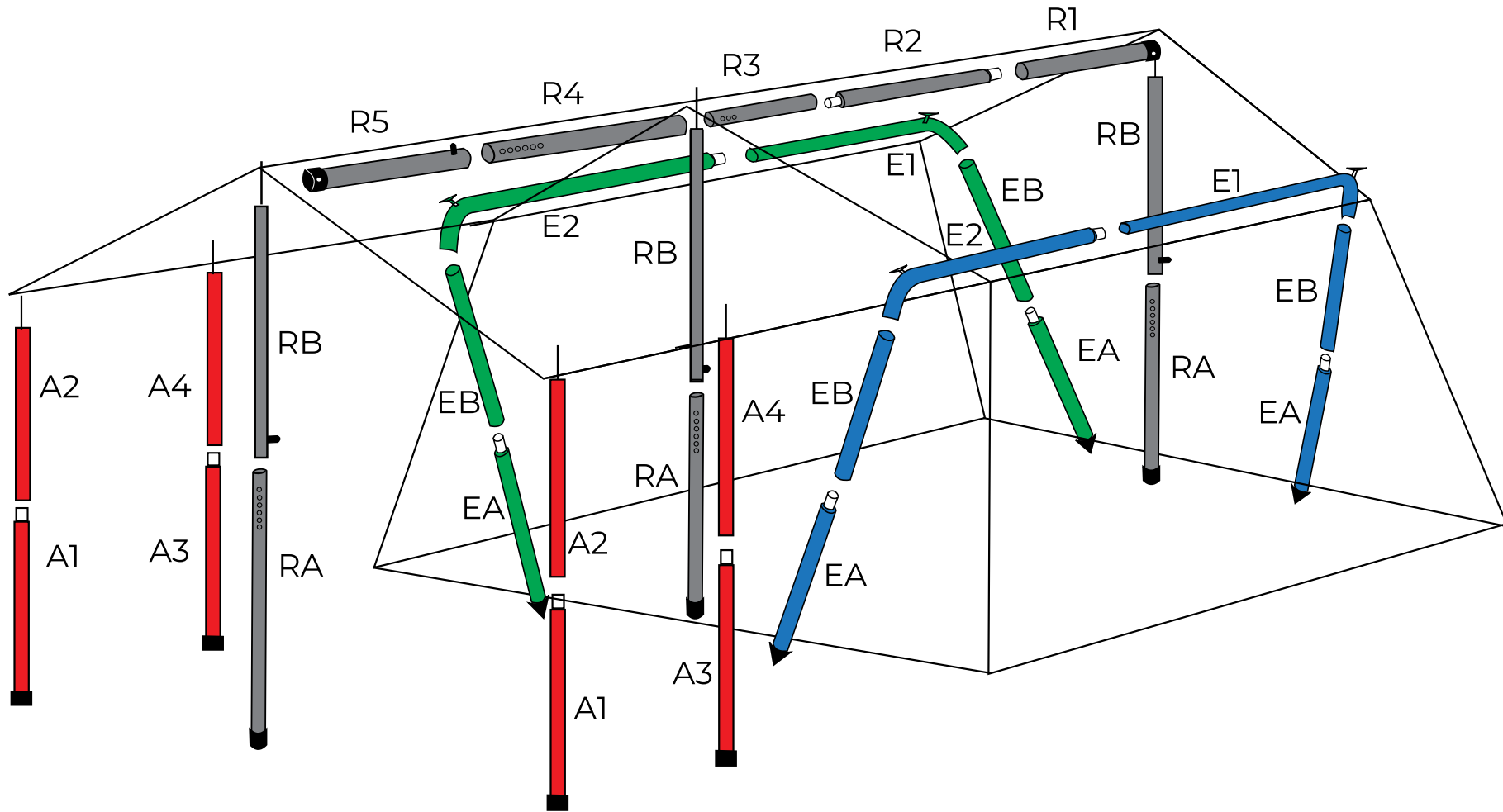

POLE CHART

Ridge Pole (BLACK)

R1 > R2 > R3
 R4 > R5
 RA > RB
 RA > RB
 RA > RB

LH Eve Pole (GREEN)

E1
 E2
 EA > EB
 EA > EB

RH Eve Pole (BLUE)

E1
 E2
 EA > EB
 EA > EB

Awning Pole (RED)

A1 > A2
 A1 > A2
 A3 > A4
 A3 > A4

Crinkle Cut Pegs 11mm x 4

Crinkle Cut Pegs 6mm x 24

Witch Hats x 7

Rubber Pole Supports x 2

Guy Rope 4m x 2

Guy Rope 3m x 4

PITCHING INSTRUCTIONS

1. Clear your site making sure there are no sharp objects. Try to choose a site that is flat and clear.
2. Sort the poles into their matching colour. Once sorted, connect each colour pole section as per the pole chart on the previous page

3. Spread your tent out with floor facing down. The front is the end with the large awning roof attached.

4. Peg out the four corners of the tent, pulling the floor as tightly as possible. (Pegs should be at a 45° angle away from the tent for greatest hold.) To ensure the floor sits flat it may be easier to peg in the following sequence:

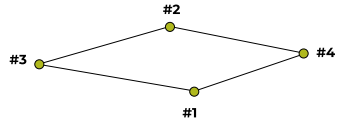

5. Peg out the remaining peg points to ensure the floor sits flat.

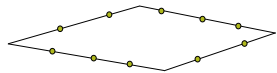

6. Open all doors and windows. This allows air to enter the tent and makes pitching easier.

7. Thread the **BLUE E1** pole through the sleeve that runs along the RHS of the tent. Thread the pole from the rear of the tent, inserting the pole through the black webbing loop before threading through the pole sleeve. Then hook the webbing loop behind the button pin on the pole.

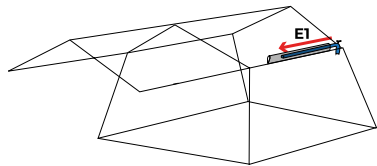

8. At the front of the tent, thread the **BLUE E2** pole up through the pole sock on the side of the front awning from the inside to the outside. Thread the pole through the black webbing loop before inserting into the pole sleeve and connecting to the E1 pole. Hook webbing loop over button pin.

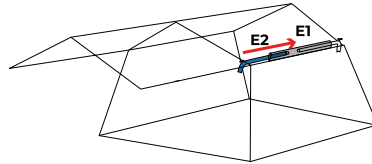

9. Cover the pole by wrapping the end of the pole sleeve over the pole sock and secure with velcro.

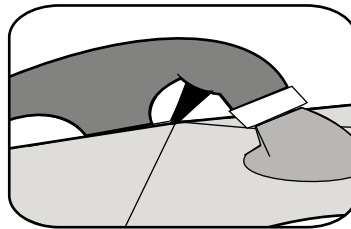

10. Repeat steps 7-9 with the **GREEN** pole.

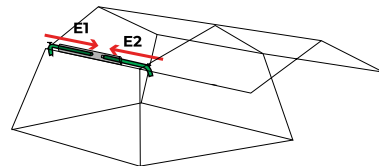

11. Insert the remaining **BLUE EA** and **EB** poles into the end of each section and raise the pole so that the outside wall sits taught. You will need two people to do this.

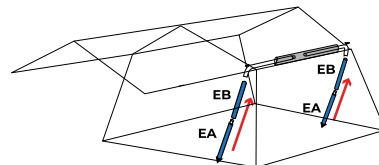

12. Repeat with the **GREEN EA** and **EB** poles.

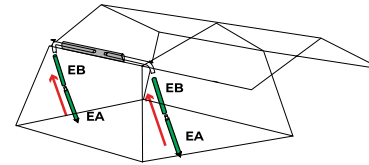

13. Thread the **BLACK R1** to **R3** ridgeline poles into the tent through the pole sock at the top of the front wall.

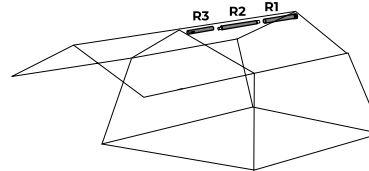

14. Insert the **BLACK RB/RA** pole into the hole at the end of the **R1** pole and then through the eyelet at the rear of the roof and extend until the wall sits tight. Secure the velcro strips on the rear wall.

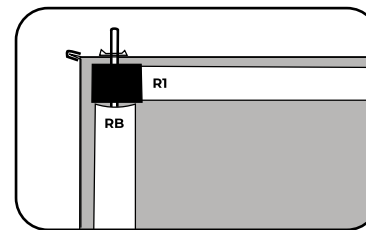
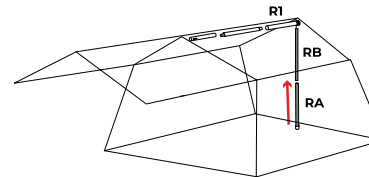

15. Repeat with the second **BLACK RA/RB** pole at the front of the tent. Thread the **RB** pole through the outermost of the 3 holes on the **BLACK R3** pole. If the roof is too tight, move back one hole before threading through the eyelet in the roof. Ensure the end of the **BLACK R3** pole extends out through the pole sock on the front wall. Secure the velcro strips on the front wall around the pole.

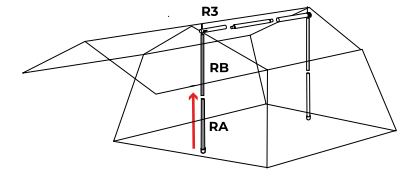

16. Place white "Witch Hat" spike washers onto the pole spigots of both **RB** poles to prevent water running down during heavy rain.

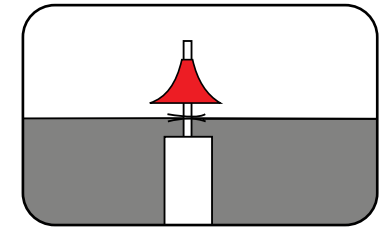

17. Insert the **BLACK R4/R5** pole into the end of the **R3** pole that extends through the pole sock at the front of the tent.

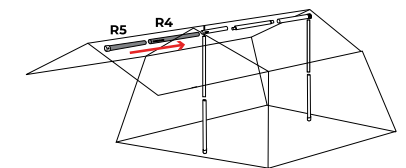

18. Insert the **BLACK RB/RA** pole into the hole at the end of the **BLACK R5** pole and then through the eyelet at the end of the awning. Extend by unlocking the fliplock.

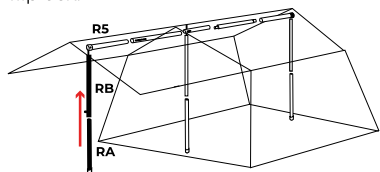

19. Extend the **BLACK R4/R5** pole until the awning is tight. If unable to reach, you may need to lower the pole by moving the support poles to the side.

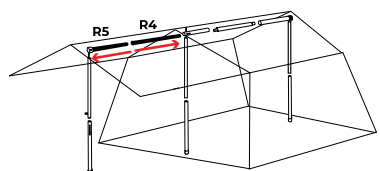

20. Insert the **RED A1/A2** poles into the eyelets at the front corners of the awning.

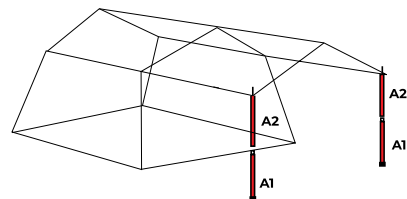

21. Place white "Witch Hat" spike washers onto the pole spigots of both **A2** poles to prevent water running down during heavy rain.

22. Guy out the front awning by attaching the short guy ropes over top of awning pole spigots. Line up the guy rope with the pole spigot and the top ridgepole spigot (indicated by the - - Line). Ensure the guy rope is at a 45° angle.

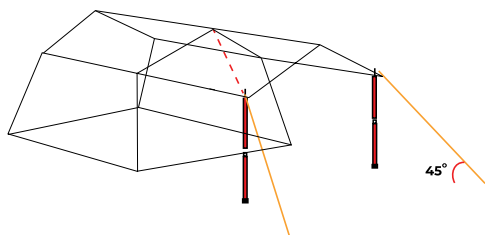

23. Insert the longer **RED A3/A4** pole into centre of the side of the awning. Guy out at a 45° angle with the longer guy rope sections.

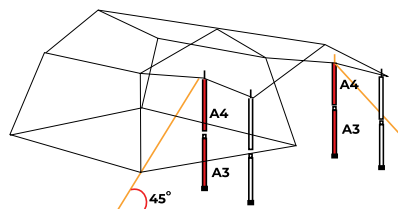

24. Place white "Witch Hat" spike washers onto the pole spigots of both **A4** poles to prevent water running down during heavy rain.

25. Peg out front valance. The bottom of the valance should sit level with the ground. The outside of the valance should align with the outside of the tent. The inside of the valance should be vertical.

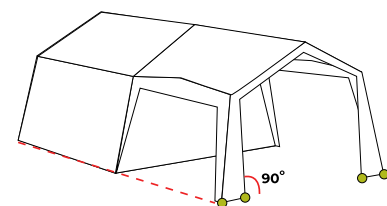

26. Place rubber pole supports under support poles. (**BLACK RA**)

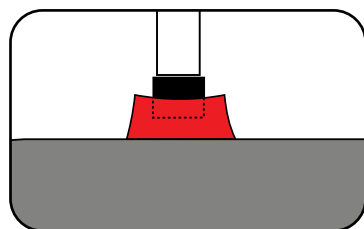

PACKING AWAY YOUR TENT

1. Open up all windows and close all doors.
2. Remove the **RED** awning poles.
3. Remove the **BLACK** ridge poles.
4. Remove the **BLUE & GREEN** eve poles.
5. Remove all pegs, clean and place in peg bag.
6. Lay the tent as flat as possible and fold the awning over the body of the tent.
7. Fold both sides into the centre of the tent.

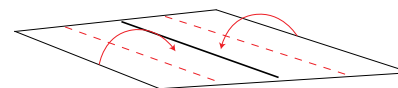

8. Fold in half. Ensure the width is the same as the length of your carry bag. Adjust if necessary.

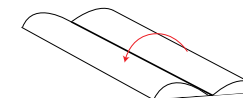

9. Expel as much air as possible by walking down the tent towards the door.

10. Roll the tent from the rear towards the door. Ensure that you wipe off any condensation and dirt as you roll.

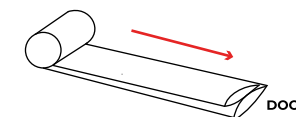

Condensation

It is important that lower vents are opened at all times to reduce the risk of condensation. During humid or damp conditions, it is recommended that the window covers are opened to expose the mesh layer, enabling additional airflow throughout your tent.

Do not use foam swabs or non-bonded mats directly on the tent floor. This will cause condensation between the mat and floor and if not dried out, can lead to mildew forming.

For a detailed description of all the features and specifications please visit our website.

WEATHERING YOUR TENT

When you first get your new tent, you will need to weather it. This is a process of soaking the fabric to ensure the cotton threads swell up, reducing stitch holes and creating a watertight surface.

When you pitch your tent for the first time, wet the tent with a garden hose until the fabric is visibly damp. Allow to dry and repeat two or three times.

Your tent will get more watertight the more you use it. Do not be concerned if you have a small amount of water coming through the seams on the first few times you get heavy rain.

Natural Fibre

Our ZEMPIRE® Canvas material is a combination of cotton (for breathability and water fastness) and polyester (for strength). You may notice variations of both colour and thread thickness. This is completely normal with a natural breathable fibre.

Fire Retardant

ZEMPIRE® Canvas Tents are naturally fire retardant. While this significantly reduces the risk of the fabric catching on fire, it is by no means fire-proof. Ensure open flames are kept well away from your tent at all times.

CARE INSTRUCTIONS

1. Ensure guy ropes are out at all times during use.
2. Make sure you have all vents open at all times. Constant airflow will drastically reduce condensation in humid weather conditions. Never cook in your tent as it is unsafe and would also heavily increase condensation.
3. Ensure all doors are zipped closed before inflating and deflating. This helps keep the tent's shape and prevents stress on panels/zips.
4. Never pack your tent away wet. If you must take your tent down when wet, ensure that it is dried completely as soon as possible to prevent mildew forming.
5. If mildew does form on your tent, wash off with warm water and a soft brush to prevent further growth, do not use soap or detergents.
6. Do not use aerosol spray cans or an open flame inside your tent. The fabric has been treated with a fire retardant but is in no way fire-proof.
7. Always use a peg puller to remove pegs. Never remove pegs by pulling the tent or peg loops; always clean and dry pegs before storing.
8. This tent is not designed to withstand storm conditions. During a severe storm, it is recommended that the tent be taken down.
9. Do not leave your tent pitched unnecessarily for extended periods of time. UV light damages the fly and will shorten the life of your tent.

NEED HELP WITH YOUR TENT?

We have a range of videos on our website which can help you.

Follow the QR code or type the link below in your browser. We suggest to check out our videos beforehand in case you don't have service at your holiday destination.

TO THE
VIDEO
GALLERY



ZEMPIRECAMPING.INFO/VIDEO-GALLERY

5 Year Limited Warranty

Please take time to read about the protection we offer you.

All our products come with a guarantee designed to protect you as our valued customer. ZEMPIRE® Camping Equipment will repair or replace this product, at their discretion, should it fail due to faulty materials or manufacture for a period of 5 years from the date of purchase.

The Guarantee is subject to the following conditions:

1. The Guarantee only applies to an original purchaser who purchased this product in an unopened condition from an approved retail outlet.
2. The Guarantee does not apply if the product has been used for anything other than reasonable personal use. Commercial use (e.g. rental) or continuous use are expressly excluded.
3. Damage due to normal wear and tear, accident, acts of God, negligence (other than by ZEMPIRE® Camping Equipment), failure by the purchaser to ensure instructions for setting up and care are observed, deterioration due to abnormal exposure to ultraviolet light, insect or mildew attack, or any other cause reasonably beyond the control of ZEMPIRE® Camping Equipment are not covered.
4. If redress is sought under the terms of this Guarantee, then the product must be returned by the purchaser to the outlet from where it was purchased within the Guarantee period, in a clean, dry state and with proof of purchase.
5. All transport costs and any other indirect costs are excluded from the Guarantee.
6. ZEMPIRE® Camping Equipment reserves the right to make a reasonable charge for repairs which it determines are not within the scope of the Guarantee.
7. The Guarantee does not limit, modify or exclude any rights under any law if doing so would contravene that law or make any part of this Guarantee invalid. However, ZEMPIRE® Camping Equipment:
 - a) excludes (to the extent permitted by applicable law) all conditions and warranties that might otherwise be implied; and
 - b) limits its liability for breach of any such condition or Guarantee that it cannot exclude together with its liability under the Guarantee, to repairing or replacing the Goods or paying the cost of having the Goods repaired or replaced (at ZEMPIRE® Camping Equipment's option).

Australia Only

Our goods come with guarantees that cannot be excluded under Australian Consumer Law. You are entitled to a replacement or refund for a major failure and compensation for any other reasonably foreseeable loss or damage. You are also entitled to have the goods repaired or replaced if the goods fail to be of acceptable quality and the failure does not amount to a major failure.

USA Only

Some states do not allow the exclusion or limitation of incidental or consequential damages, so the above limitation or exclusion may not apply to you. This warranty gives you specific legal rights, and you may also have other rights which vary from State to State.

Europe Only

The consumer has legal rights under applicable national legislation governing the sale of consumer goods and those rights are not affected by the guarantee.

All warranty claim processes are explained on our Zempire® website. Please go to www.zempire.co.nz, select your location and follow the instructions to lodge a warranty claim.

International Distributors:

New Zealand & Australia

ZEMPIRE® Camping Equipment
6 Karewa Place, Pukete,
Hamilton, 3200, New Zealand
Ph: +64 7 848 1610

United Kingdom, Belgium, Netherlands & Luxembourg

Outdoor & Sports Company Ltd.
Redfern House, Dawson Street
Hyde, Cheshire, SK14 1RD, UK
Ph: +44 161 366 5020

North America

Outdoor & Sports Company Inc.
610 Alden Road Unit 101
Markham, ON, L3R 9Z1, Canada
Ph: +1 905 940 9511

Germany, Austria, & Switzerland

Sport-tech
Goldbeckstrasse 6
69493 Hirschberg, Germany
Ph: +49 6201 8439710

South Korea

Coldspin Corporation
20 Gurodong-ro 15-gil
Guro-gu, Seoul,
South Korea
Ph: +82 2 3397 7711

Designed and tested in New Zealand. Made with care in China.



AS PART OF OUR **ZEMPIRE FAMILY**, SHARE
YOUR **CAMPING MOMENTS** ON SOCIAL

     @zempirecamping #zempirefamily